

Ultimate Flip-Lever Modern Astragal Inswing Field Installation Instructions

8817 West Market Street
Colfax, NC 27235 | 800.334.2006
www.enduraproducts.com



Tools Required:

- Pencil/Marker
- Utility Knife
- Drill (3/8" and 5/8" Bits)
- Rubber Mallet

Kit Includes:

- (1) Lower Bolt Receiver
- (1) Header Strike Plate
- (2) #8 x 3" Screws

Before you begin: Install corner pads on door hinge jambs to establish proper jamb side margins. This ensures accurate locations on header and sill for the bolt receivers.

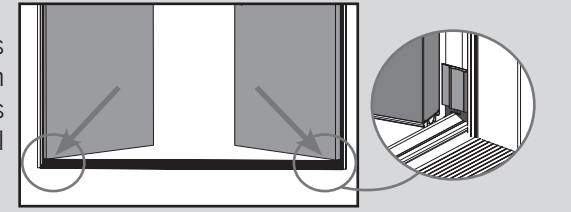

STEP 1: INSTALL HEADER AND SILL BOLT RECEIVERS

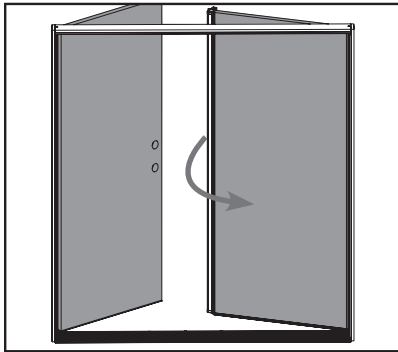

a. Close the inactive door panel until the weatherstrip on the header is compressed.

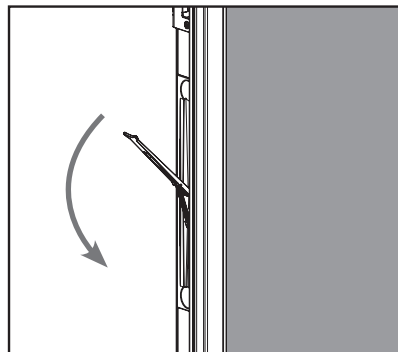

b. Engage the flip lever so the upper and lower bolt pins come in contact with the header and the sill. Mark these points of contact.

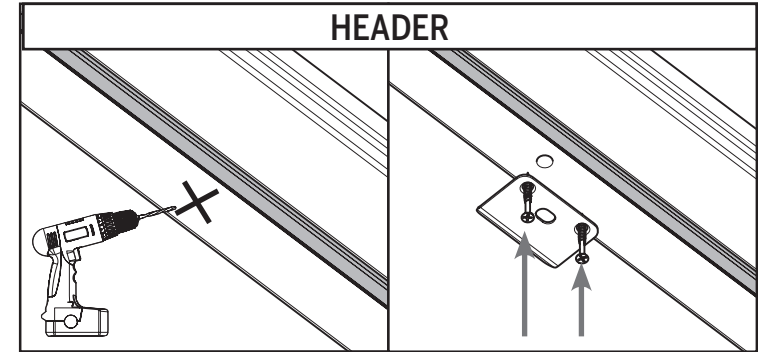
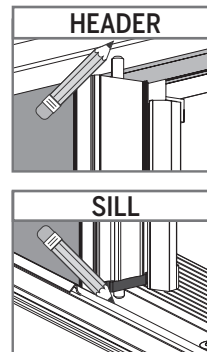

c. At the marked location on the header, drill a hole **3/8" in diameter** and at least **1-3/8" deep**. Install the header strike plate into the header, using two #8 x 3" screws.

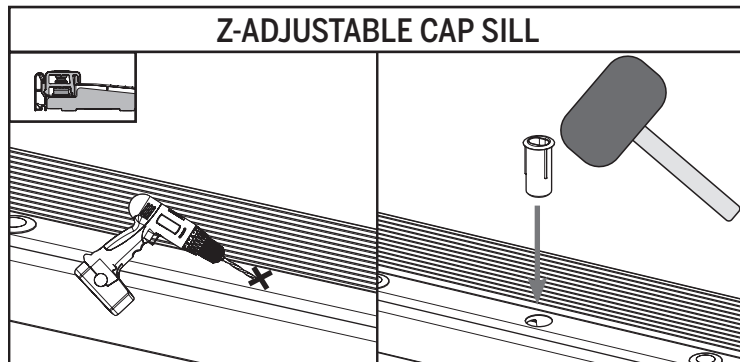

d. At the marked location on the sill, drill a hole **5/8" in diameter** and at least **1-3/8" deep**. Install the lower bolt receiver by tapping into the sill using a rubber mallet.

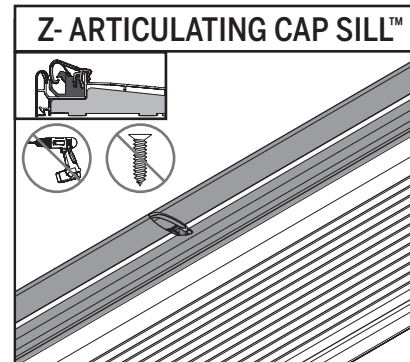

NOTE: If using a Z-AC sill, **no drilling is necessary** as the bolt receiver is pre-installed.

STEP 2: INSTALL STRIKE AND DEADBOLT PLATES

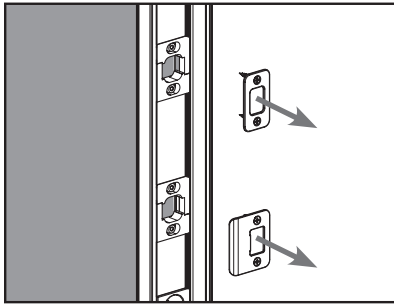

a. If installing new strike and deadbolt plates, remove the screws securing the old plates.

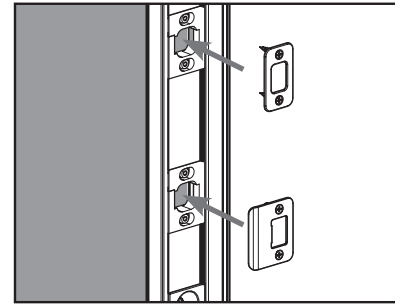

b. Install the new hardware into the retainers by tightening the screws through the holes in the plates.

STEP 3: CUT WEATHERSTRIP AT HEADER

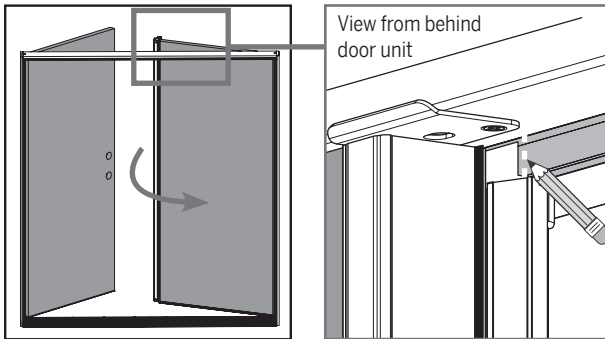

a. Close the inactive door. Make a mark at the location where the trim cap contacts the weatherstrip.

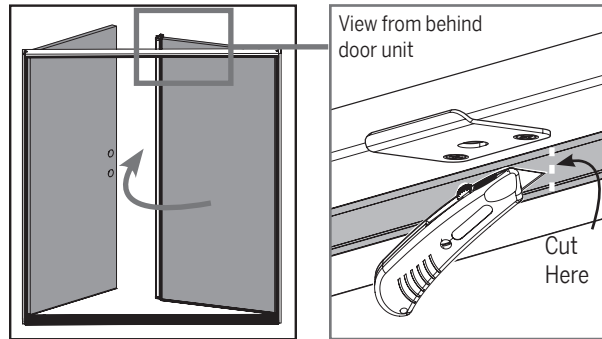

b. Open the inactive door. Using a utility knife, make a slit in the weatherstrip along the mark made.

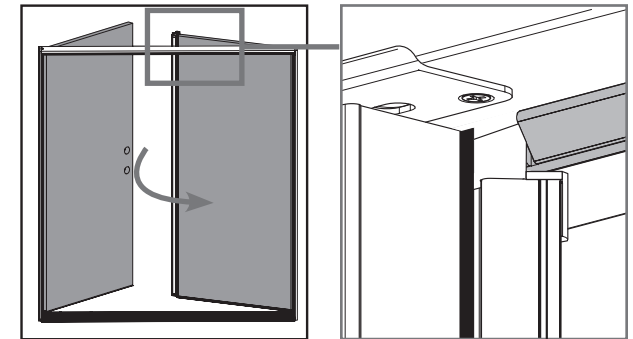

c. Close the inactive door panel. Ensure the weatherstrip forms a secure seal around the trim cap.

STEP 4: CONFIRM PROPER INSTALLATION

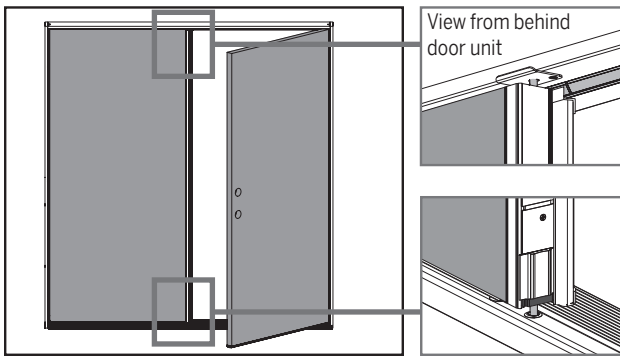

a. With the inactive door panel closed, engage both the upper and lower bolts to ensure they fit into the bolt receivers smoothly.

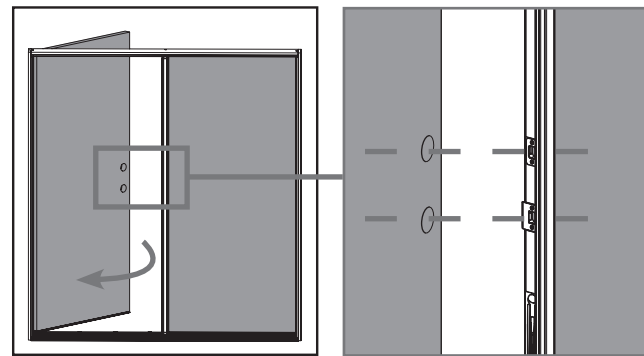

b. Close the active door panel and ensure the deadbolt and strike plates are aligned with the crossbore holes in the active door panel.

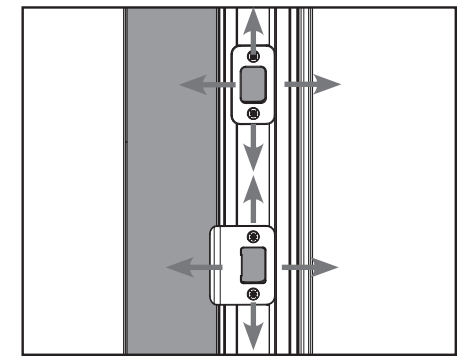

c. If the plates are not aligned correctly, loosen screws and slightly adjust the locations of the plates.