

# Ultimate PanoLock® Astragal

## Inswing Field Installation Instructions

8817 West Market Street  
 Colfax, NC 27235 | 800.334.2006  
 www.enduraproducts.com



### Tools Required:

- Pencil/Marker
- Utility Knife
- Drill (3/8" and 5/8" Bits)
- Rubber Mallet

### Kit Includes:

- (1) Lower Bolt Receiver
- (1) Header Strike Plate
- (2) #8 x 3" Screws

**Before you begin:** Install corner pads on door hinge jambs to establish proper jamb side margins. This ensures accurate locations on header and sill for the bolt receivers.

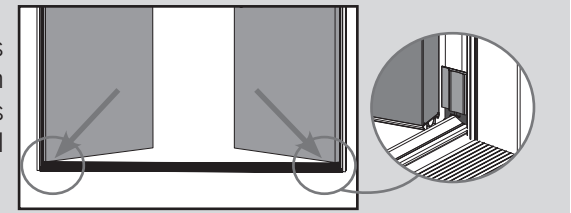

## STEP 1: INSTALL HEADER AND SILL BOLT RECEIVERS

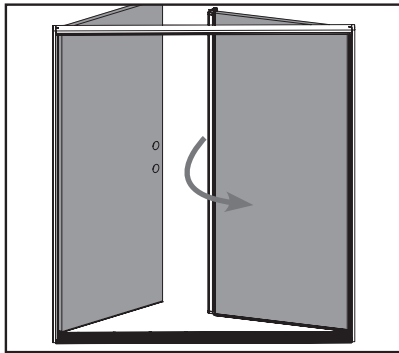

**a.** Close the inactive door panel until the weatherstrip on the header is compressed.

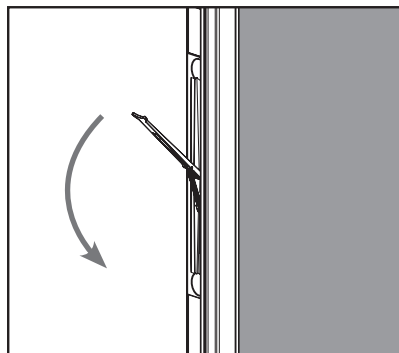

**b.** Engage the flip lever so the upper and lower bolt pins come in contact with the header and the sill. Mark these points of contact.

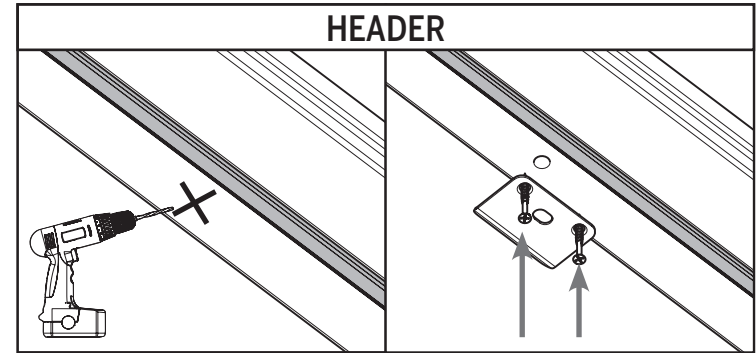
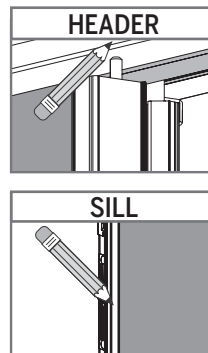

**c.** At the marked location on the header, drill a hole **3/8" in diameter** and at least **1-3/8" deep**. Install the header strike plate into the header, using two #8 x 3" screws.

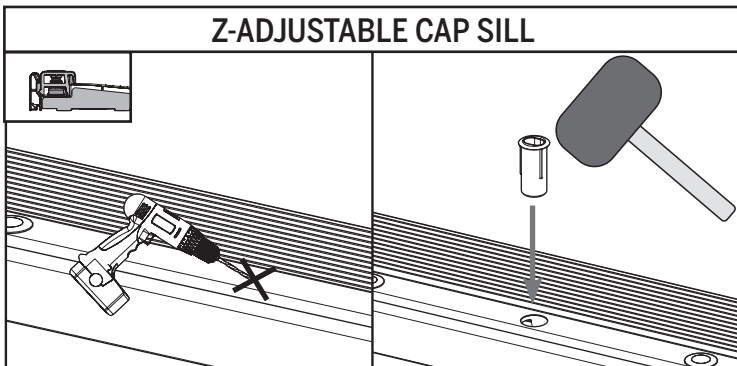

**d.** At the marked location on the sill, drill a hole **5/8" in diameter** and at least **1-3/8" deep**. Install the lower bolt receiver by tapping into the sill using a rubber mallet.

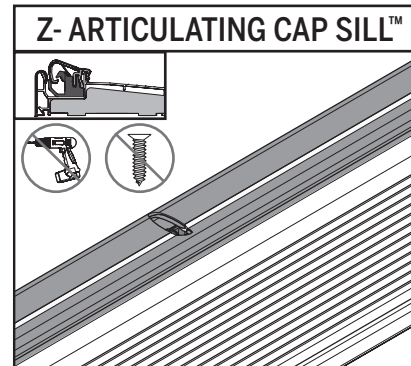

**NOTE:** If using a Z-AC sill, **no drilling is necessary** as the bolt receiver is pre-installed.

## STEP 2: INSTALL STRIKE PLATES

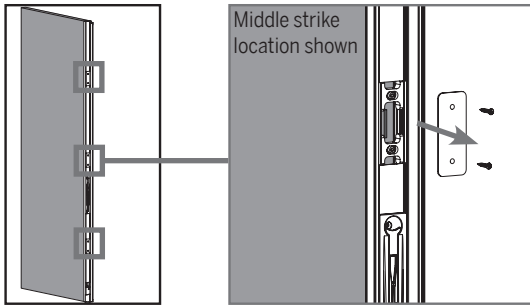

**a.** Remove the upper, middle and lower dummy strike plates.

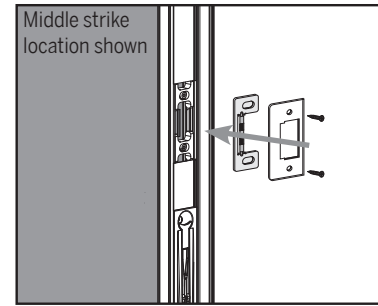

**b.** At each location install new strike plates by screwing into the retainers.

## STEP 3: CUT WEATHERSTRIP AT HEADER

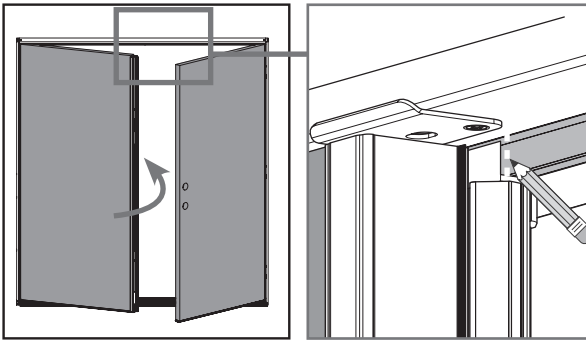

**a.** Close the inactive door. Make a mark at the location where the trim cap contacts the weatherstrip.

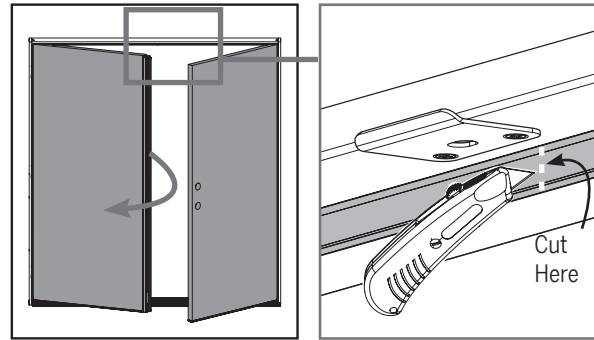

**b.** Open the inactive door. Using a utility knife, make a slit in the weatherstrip along the mark made.

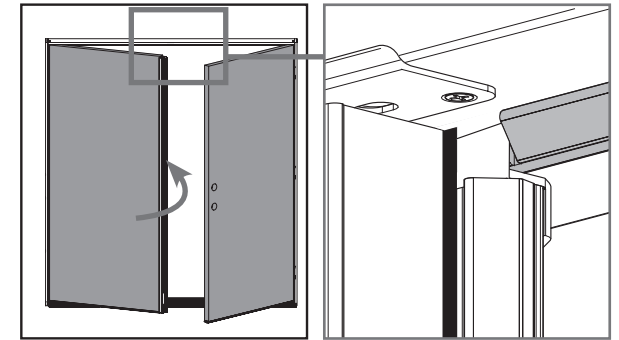

**c.** Close the inactive door panel. Ensure the weatherstrip forms a secure seal around the trim cap.

## STEP 4: CONFIRM PROPER INSTALLATION

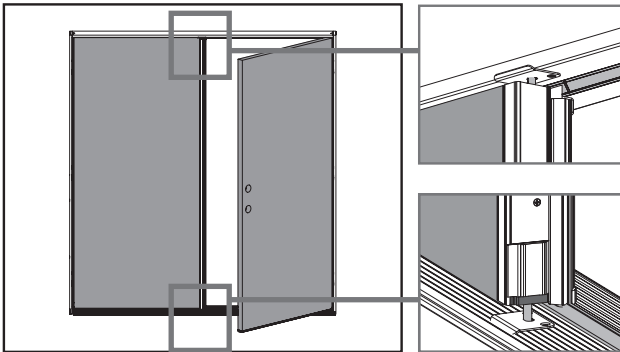

**a.** With the inactive door panel closed, engage both the upper and lower bolts to ensure they fit into the bolt receivers smoothly.

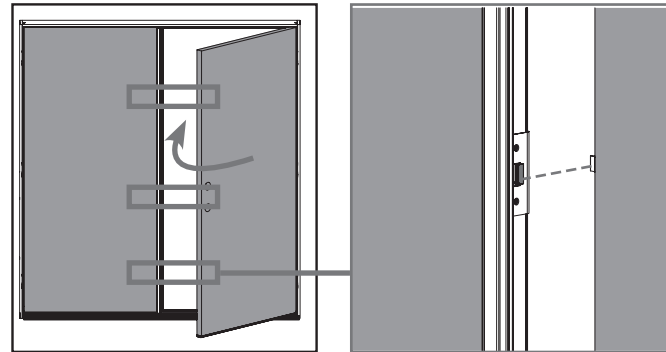

**b.** Close the active door panel and engage the lock to ensure the upper, middle and lower strike locations are properly engaged.

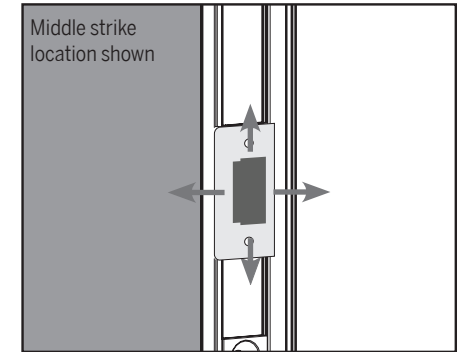

**c.** If the plates are not aligned correctly, loosen screws and slightly adjust the locations of the plates.