

PanoLock™ Multi-Point Lock Instructions

Door Panel Machining - Lock Mortise



8817 West Market Street
 Colfax, NC 27235 | 800.334.2006
 www.enduraproducts.com

⚠ WARNING – Make sure router is unplugged when adjusting bit depth.

⚠ WARNING – Use proper personal protective equipment when operating a router.

Machining details are found in Endura print # 16031-299.

REQUIRED TOOLS:



A plunge base router
 (1/2" Collet & 2-7/8" Minimum Plunge Depth)



A standard two-flute
 1" router bit

PanoLock Templates and Accessories for Door Panel.

1. Two Rails (for 6/8 & 8/0 Doors)
2. Two Bridges
3. Two Handle Bore Drill Guides (w/3 screws ea)
4. Eight Stops
5. Two Metal Stops
6. PanoLock Support Pin
7. One Router Base
8. One Endura Custom 1" Dia X 5" Router Bit
9. Depth Guide
10. Router Base Centering Donut
11. Bore Centering Guide
12. Routing instructions

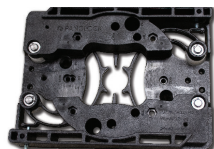
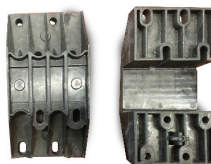

Save time and increase shop efficiency. If you plan to route multiple doors frequently, we recommend purchasing two sets of rails and routers, keeping one preset for 6/8 doors and one for 8/0.

STEP 1 - ASSEMBLE THE RAIL SYSTEM

1-1. Install the two handle bore guides to the rail system.

Locate the raised lip on the drill guide which fits into the larger guide hole on the rail. This ensures the guide is oriented properly and sits flush against the rail when attached.

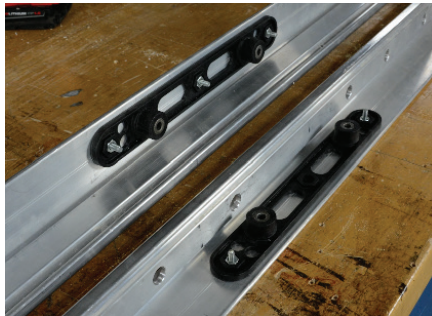

1-2. Position the rails with the two bottom edges and two top edges aligned.



Top



Bottom

1-2. Connect two rails with the bridges.

The two bridges included with your PanoLock routing template kit have slotted openings on one side and through holes on the other. **The bridges will only attach to the rails in one orientation by aligning the tapped hole patterns on the rails with the through holes on the bridges.** Align the hole patterns on the bridges with the hole patterns on the rail.

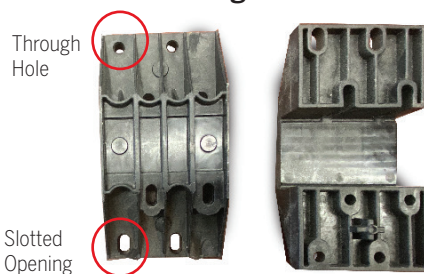

Attach the bridges to the rails using a 3/16" allen wrench to fasten four 1" screws through the holes as shown. Use two 1" screws and two 2" screws to fasten the slotted side of the bridges to the unlabeled rail as shown.

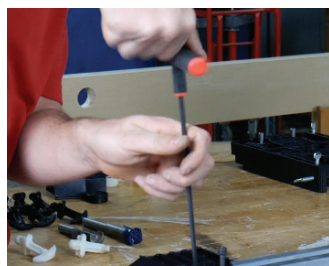
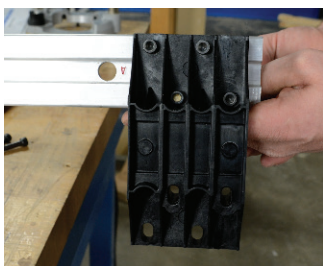

Note: Screws on the slotted side of the bridge should be snug, but not tight. Loosely fastening them at the widest setting will allow you to easily adjust the fit of the rail against the door panel later.

Repeat this process at the top of the rail system, making sure to fasten the second bridge to the top of the rail system using the guide holes near A6 for a 6'8 door or near A8 for an 8'0 door.

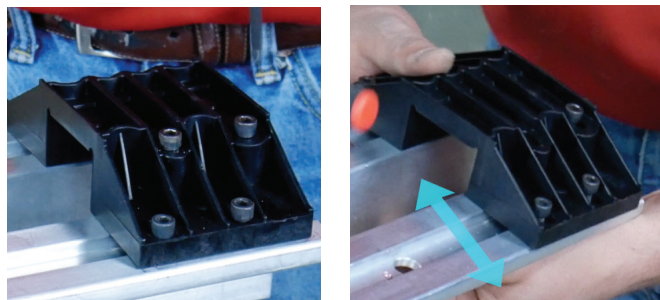

STEP 2: PREPPING THE ROUTER BASE TEMPLATE AND ATTACHING IT TO THE ROUTER:

2-1. Prepping Router Base Template

a. The PanoLock router base template will come as shown with four preassembled rollers.

b. Use the four thumb screws included with your template kit to set up the router base prior to attaching it to the router. To do so, thread two of the thumb screws through the two exterior guide holes on opposite corners of the base template indicated here. Stop tightening the thumb screws as soon as you see contact with the inner wall of the base template. These will be adjusted later to ensure the router base fits snugly against the door panel.

c. Now, thread the other two thumb screws through the guide holes perpendicular to the long thumb screws. Stop as soon as you make contact with the longer thumb screws to hold them in place.

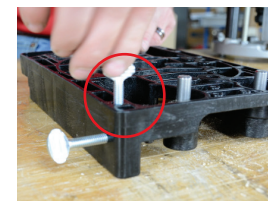
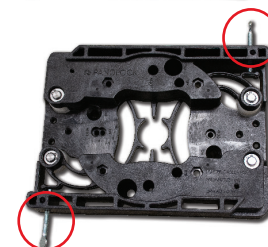
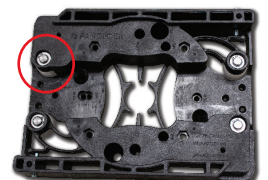

2-2. Attaching router base template to router

Please note: some of the following steps will vary slightly depending on your particular router. The router base template is designed to accommodate most routers including DeWalt, Porter Cable, and Milwaukee routers.

a. Place the router base against the bottom of the router, placing it as close to centered as possible. Gradually shift the position to align the mounting hole patterns on the router base with your router's mounting hole configuration. Note: the base template may not be completely square with the router once the guide hole patterns are properly aligned. This is okay as we will center the router to the base in the following steps.

b. Use the screws that came with your router to fasten the base to the router, but do not tighten the screws all the way at this point in the process.

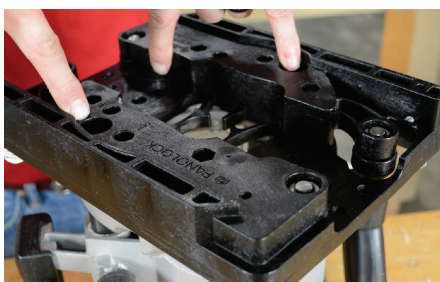
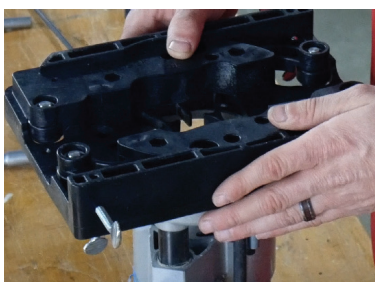

2-3 Center the router and router base.

To center the router, place the router base centering guide in the center of the router base, and insert a router bit into the collet through the center of the donut. We will use the shaft of the router bit to align the router with the centering donut and the router base.

Now, tighten the collet around the router bit. As you tighten the collet, you should notice the router base shifting positions due to the centering donut being in place since we left the mounting screws slightly loose earlier in this process. Once the collet is tightened, you can tighten the mounting screws used to attach the base to your router. Gradually tighten each mounting screw until the base is secure, being careful not to overtighten at any point, as this could pull the base off center.

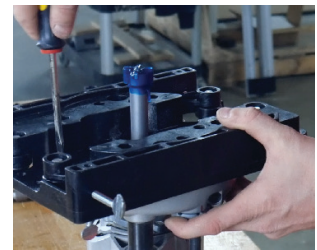
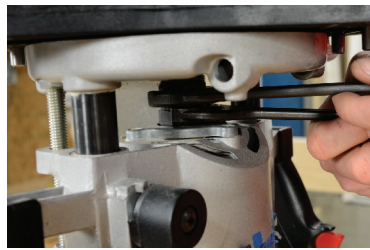
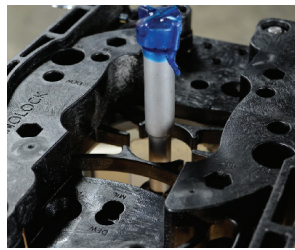
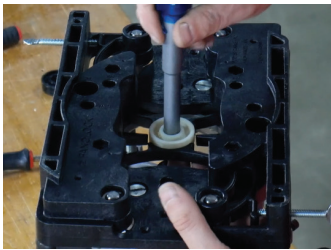
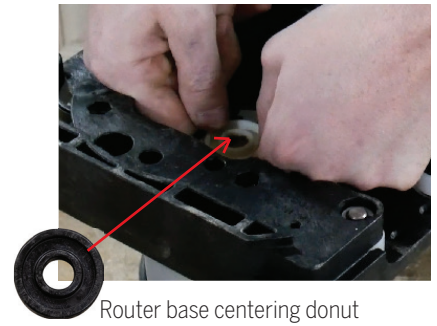

2-4. Once the base template is securely fastened to the router, you can remove the router bit and router base centering donut.

STEP 3 - POSITIONING THE RAIL SYSTEM ON THE DOOR PANEL.

3-1. Set up your door panel with latch bores facing up.



3-2. Locate the center of the latch bore on your door panel. You can either measure this according to the specifications for your door panel and draw a line indicating the center line of the latch bore, or you can use the bore centering guide, provided with your template kit.

To use the bore centering guide, place the guide into the latch bore. Place the router base on the door panel directly over the bore centering guide. Locate the guide hole as shown, and slide the rail system to align the guide hole until the included pin can be inserted through the router base and the rail.

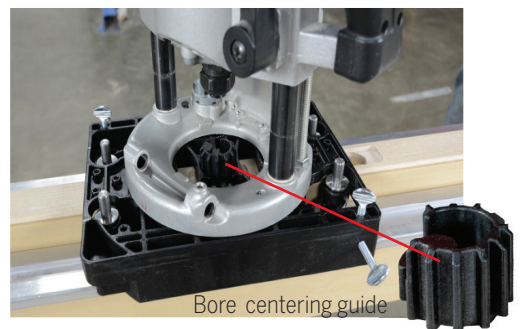

3-3. Before placing the rail system on the door panel, insert the support pin through the deadbolt bore (or through the deadbolt guide on the bore drilling guide if your panel isn't premilled) with the flat side up. This step prevents sagging during the routing process.

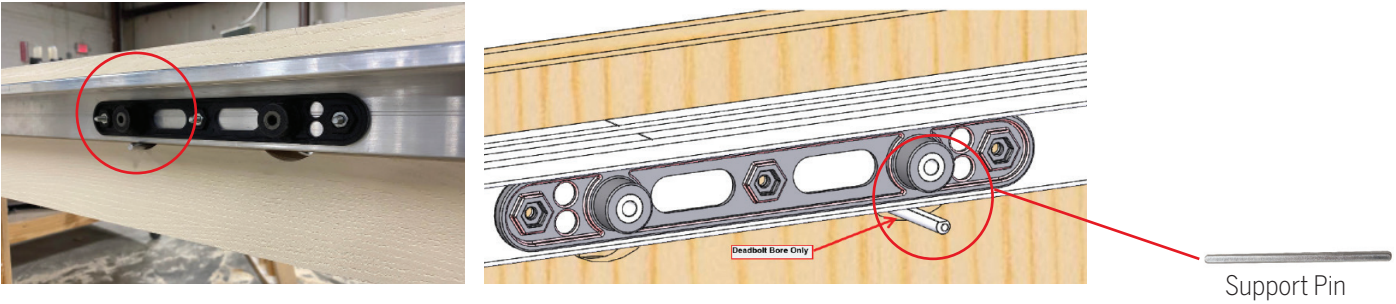

3-4. Now, place the rail system on the door panel with point A6 or A8 (depending on the size of your door) at the top of the door panel and point A at the bottom, and align the pre-marked center line scribed on the rail system with the center line you just marked on the door panel.



3-4. Adjust the rail system using the slotted side of the bridges until the rail is snug against the panel and tighten firmly with screws.



3-5. Ensure the bridge is tight along the door panel and clamp the rail system to the door panel, ensuring the clamps are out of the way. Note: the bridges are preset to fit 1 3/4" door panel, but they can be adjusted to fit the width of most doors.



STEP 4 -SETTING UP THE ROUTER TO ROUTE THE FIRST POCKET:

4-1. Fully extend the router to its shallowest depth and insert the standard 1" router bit so that the bit does not extend below the face of the base.

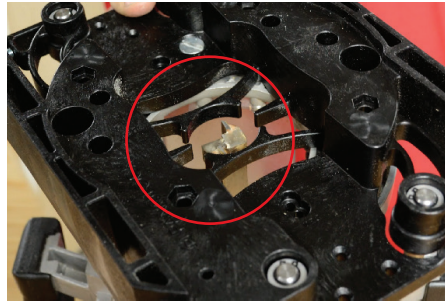

4-2. With the router turned off, place the router over the door panel and plunge until the router bit makes contact with the panel. This will be your "zero" location.



4-3. Using the depth gauge included with your PanoLock template kit, set the stop on your router to a route depth of 1/2". Note: If using the gauge to double check the route depth off the panel, the edge of the router bit will be slightly lower than the 1/2" mark on the depth gauge. This is normal and accounts for the additional width of the base template.



Depth gauge



STEP 5 - IDENTIFY ROUTING STOP POINTS

Identify the following points along the rail system: A8, A6, B, C8, C6, D, E, and F. You will use these points to determine where to place the stops for each route. Let's take a closer look:

First Route at 1/2" depth:

A - The two metal stops will be used in the "A" points for the faceplate route. Insert the stop at points A and A6 or A8 and tighten the nuts securely. Note that you will use A6 for 6/8 door or A8 for 8/0 door. This is what you will use for routing the first pocket.

NOTE: The metal stops placed in A and A6/A8 can remain in place for the full routing process and will not affect other routes, but you will need to remove one in order to "zero out" your router between the first and second routes.

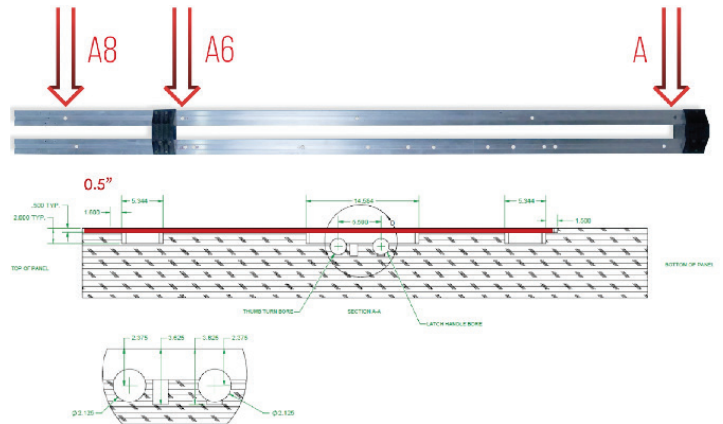
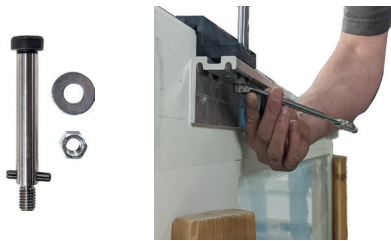

Second Route at 2" depth:

B - Marks the pocket for the bottom auxiliary bolt

C - Marks the pocket for the top auxiliary bolt. Note that you will use C6 for 6/8 door or C8 for 8/0 door.

D - Marks the pocket for the center mortise box.

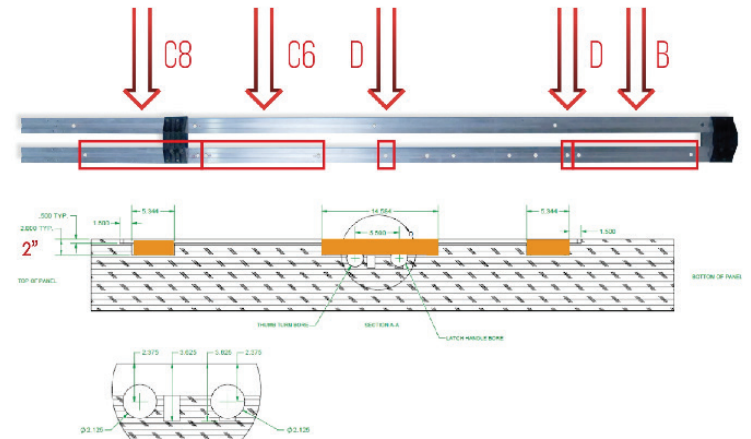

Third Route at 3-5/8" depth (to be completed with the special Endura router bit)

E & F - Both "E" and "F" points mark the locations of the two PanoLock clearance pockets.

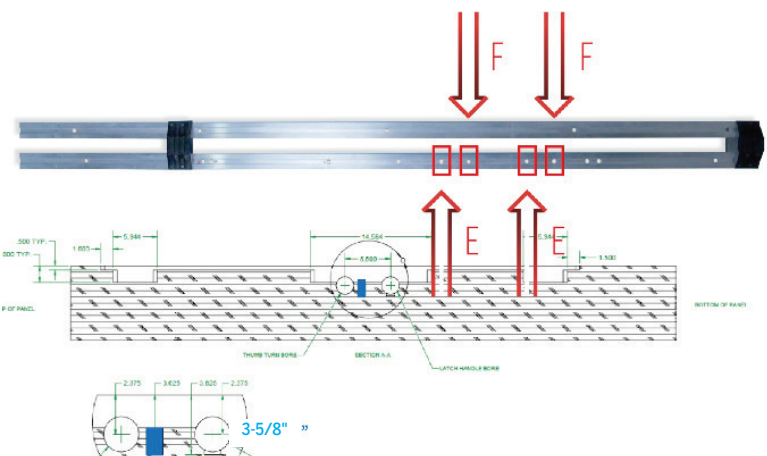

STEP 6 - FIRST ROUTE: THE FACE PLATE POCKET

6-1. With the two metal stops in place at A and A6/A8.

6-2. Now, begin routing the door between the two "A" stops. This should take several passes to ensure a smooth cut and to protect from burning up the router bit. We recommend routing about 1/8" at a time. Note: raising the router bit between pass throughs allows for a smoother cut.

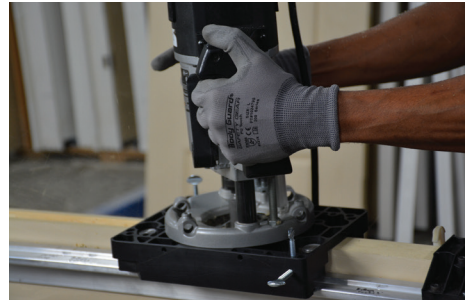

6-3. Please note, you'll need to clear the debris out of your path in between passes to ensure you're reaching the full length of the route.



6-4. Place the PanoLock faceplate upside down in the routed opening. The back of the lock faceplate should be flush with the edge of the routed pocket if the depth of the routed pocket is 1/2".

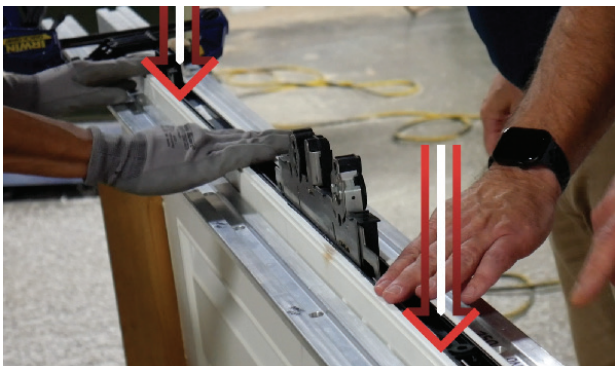

STEP 7: SECOND ROUTE: THE AUXILIARY BOLTS AND CENTER MORTISE BOX POCKETS

7-1. Zero the router on an uncut portion of the door panel, exactly as done previously, and then set the plunge stop to 2" using the depth gauge.



Depth gauge



7-2. Place a stop in each "B" marker at the bottom of the door and a stop in each "C" marker at the top of the door panel to route the pocket for the top and bottom auxiliary bolts. This will require 4 stops total; 2 at each B marker, and 2 at C6 or C8. Place stops in the holes marked "D" to set the parameters for routing the pocket for the center mortise box.

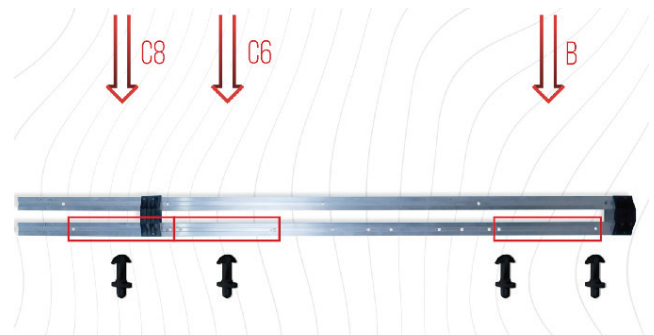

7-3. Route the top and bottom pockets before routing the middle pocket.

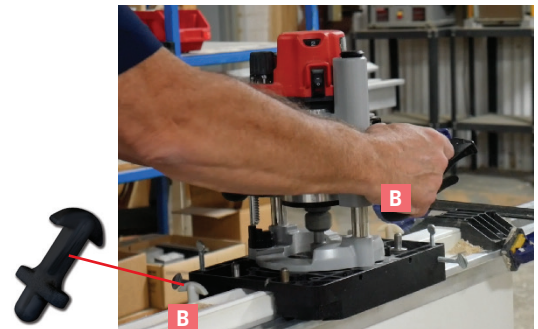

7-4. Before routing the center mortise, double check that your router is set at the appropriate depth. Measure the top and bottom sections to make sure they don't exceed 2" in depth. If your center section exceeds 2" in depth, your PanoLock will not fit appropriately in your door panel.



7-5. After you've confirmed the plunge depth and made any necessary adjustments, route 2" deep in the center mortise as indicated here.

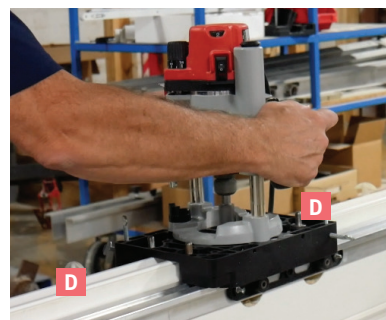
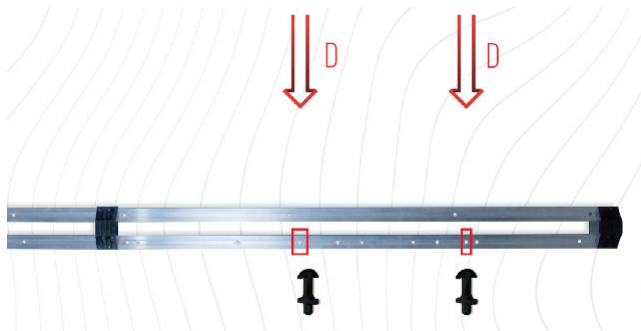

STEP 8: FINAL ROUTE: THE CLEARANCE POCKETS

8-1. Move the stops to points E. Routing the deepest pocket will require the Endura custom router bit.

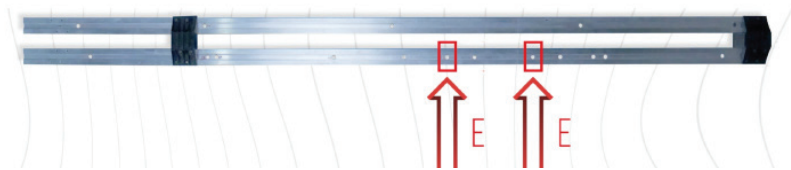

8-2. Leaving the router set for the 2" plunge depth, and pressed against the stop, remove the standard router bit and replace it with the Endura router bit that came with your PanoLock routing template kit.



8-3. Insert the Endura router bit until the edge of the cutter is flush with the top rib of the depth gauge, which will give you a plunge depth of 3-5/8".

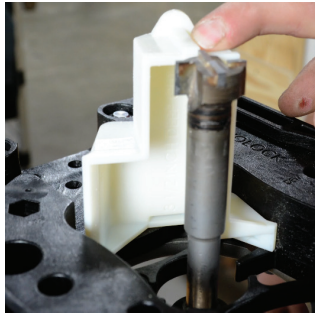

Do not use the door panel to set the zero depth on the router this time. If you zero out the router with the custom router bit inserted, your final route will not be deep enough to properly fit your PanoLock.

8-4. When routing this section, check the depth periodically to prevent plunging too far into the door panel. This will be your deepest and final cut and should be 3-5/8" deep. Note: exceeding this depth may break the glass in doors with flush glazed glass panels.

8-5. Move the stops to points F and repeat step 8-4.

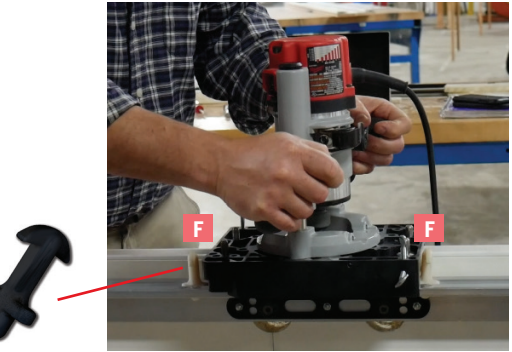
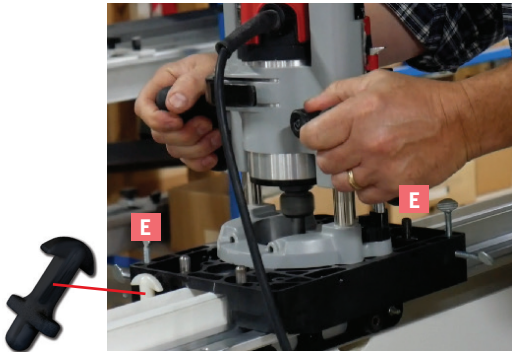

STEP 9: CHECKING THE FIT:

After routing the 3-5/8" pockets, clear away any remaining debris and place the lock into the routed opening. The lock should be flush with the edge of the routed pocket.

If the lock sits above the edge of the routed opening, you may need to deepen the final cut until the lock sits flush.



STEP 10: LOCK ASSEMBLY + HANDING

10-1. Now that your door is routed for PanoLock, you're ready to secure it in place using two 3" screws on either side of the latch bolt and 1-1/2" screws in all other mounting locations as shown here.



3" Screw

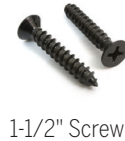

1-1/2" Screw

10-2. Make sure the latch orientation is handed correctly for your door. The tapered edge of the latch bolt should face the side of the door panel that makes contact with the weatherstrip.



10-3. To change the handing, make the needed adjustments by extending the latch all the way and loosening the bolt screw with a 9/64" allen key. Rotate the bolt 180-degrees and re-install it by tightening the bolt screw. Make sure the anti-saw sleeve stays in the bolt during this process, and be sure to put it back in place if it falls out. Tighten the retaining bolt securely but take care not to overtighten as it could strip the threads of the bolt.

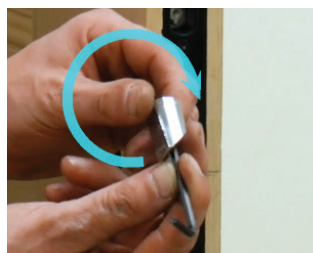
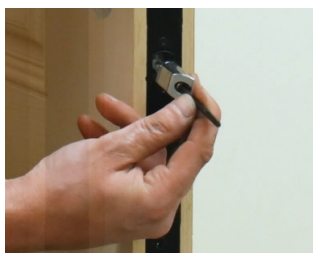

PanoLock™ Multi-Point Lock Instructions

Door Panel Machining



Machining details are found in Endura print # 16031-299.

8817 West Market Street
 Colfax, NC 27235 | 800.334.2006
 www.enduraproducts.com

