



Proven performance for your door system.

Z-Series Adjustable Sills

Z-Series Adjustable Door Sills are simply the best sills on the market. These sills use a patented design of all synthetic components that eliminates the worries of wood and ends callbacks. Built to last. Protect your door frame from unsightly damage, undesirable rusted screws, discoloration, deformity, gaps and dents. Demand the best. Demand Performance Standard.

POWERED BY
ENDURA 

Z-Series Adjustable Sills



Why buy Z-Series Adjustable Sills?

No more air and water infiltration.
No rotting, warping or deterioration either.

That's Performance Standard.

- **Proven in the field**—Z Series Adjustable Sills were developed to address real-world problems that builders face in the field, ending callbacks.
- **Built to last**—Technologically advanced all-composite substrates, synthetic caps and nosing mean no rotting, warping or deterioration over time. Screw covers keep debris out for easy adjustability anytime. Integrated seals stop water and air infiltration.
- **Choose your style**—inswing, bumper outswing and continuous mull pack sills in a variety of colors, styles and sizes make it easy to meet your specific application needs.
- **Z-Series modularity means savings and flexibility**—operating panel caps and sidelite caps can be assembled in almost endless combinations, holding your inventory count down while offering a larger variety of door configurations.

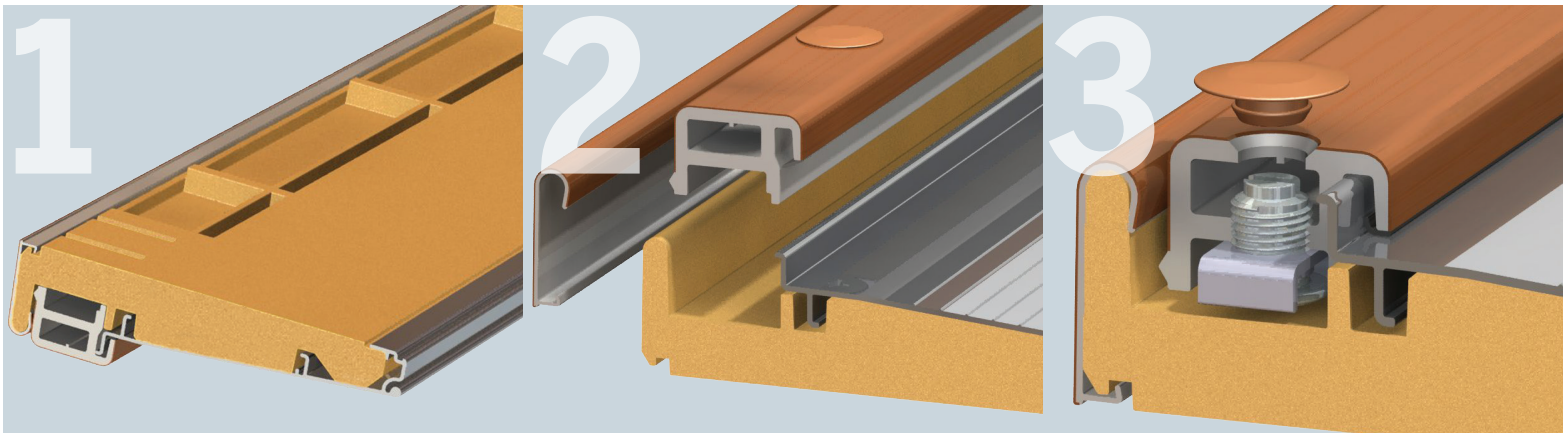

Composite Substrate

No more stuck doors or drafts because the Z-Series Sill substrate material is a waterproof composite that won't rack, warp or rot, ever. The substrate is not affected by moisture and rot like wood.

Composite Cap and Nosing

Extruded cap and nosing finishes provide resistance to wear and discoloration and offer a unique aesthetic appeal. The synthetic material used in the cap and nosing prevent warping, rotting and wear.

Sealed Adjustment Screws

Dirt and water can get into the exposed screws of other adjustable sills. Patented sealing plugs hide unsightly screws and keep water and dirt away from the adjustment mechanism, maintaining adjustability of the sill cap over time.



Inswing Sills

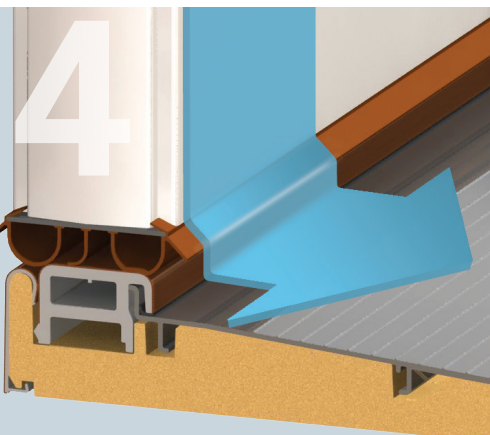

Narrow Cap
 Because of the narrow threshold cap, the drip edge on the door bottom deflects water a full 1/4" in front of the cap, protecting against air and water infiltration.

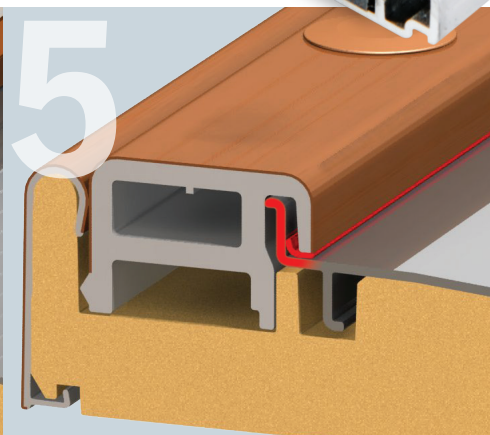

High Dam, Integrated Seal
 A dual durometer cap seal overlaps the high dam. Both combine to provide a barrier to air and moisture even in the most extreme weather conditions.

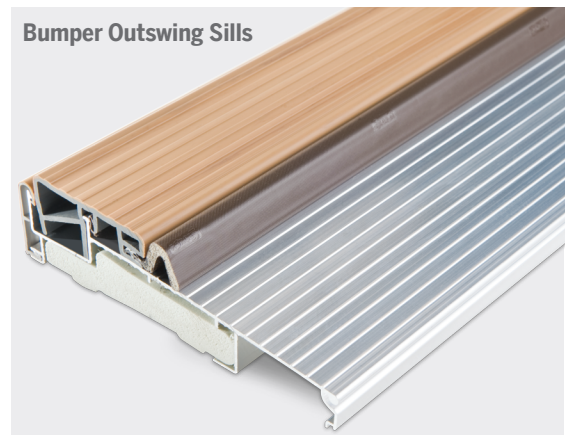

Bumper Outswing Sills



Continuous Sills

Z-Series Adjustable Sills

Z-Lineal Sill

The Z-Lineal Sill features the classic version of a full continuous extruded substrate for ultimate flexibility and custom fabrication.

- Infinite modularity, length up to 154"
- Exclusive patented repositionable active & inactive caps
- Easily converts from inswing to outswing

Z-Lineal Outswing

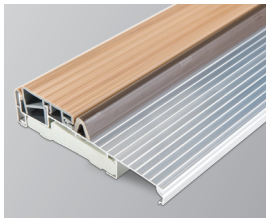

Aluminum Deck Colors*

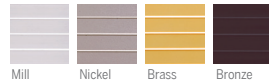

Co-Extruded Simulated Wood Cap Colors*



Z-Lineal Substrate

Z-Plus Sill

Z-Plus Sills offer a full wide substrate for a full caulking surface and thermal breaks.

- Full wide substrate
- Modular design with repositionable active and inactive caps
- CSL configurations up to 1/2-3/0-1/2; hinged patio up to 3/0-3/0-3/0
- Easily converts from inswing to outswing
- Length up to 9'0"*

*Configuration availability subject to confirmation by Endura.

Z-Plus Outswing

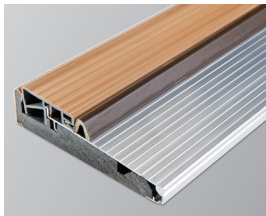

Aluminum Deck Colors*

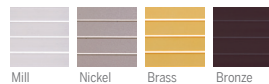

Co-Extruded Simulated Wood Cap Colors*

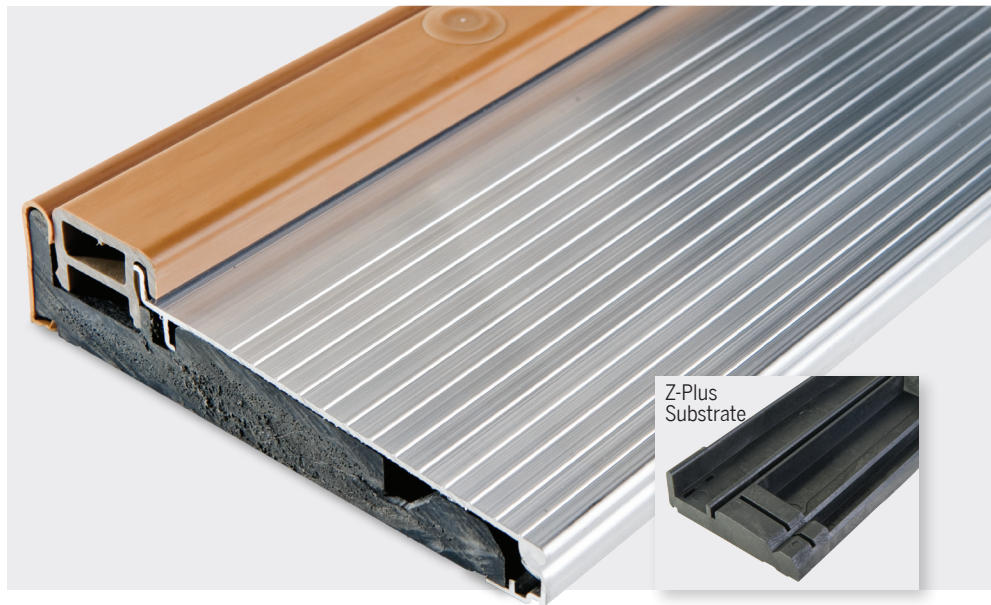
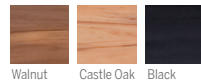

Z-Plus Substrate

Z-Full Narrow (FN)

Featuring a cost-effective full narrow substrate with full support, esthetic decorative nosing and a wide range of sizes for a uniform look in all entries.

- Full width support up to 5-5/8"
- Full-length caulking surface
- CSL up to 1/2-3/0-1/2; hinged patio up to 3/0-3/0
- Easily converts from inswing to outswing
- Length up to 6'-0"

Z-Full Narrow Outswing

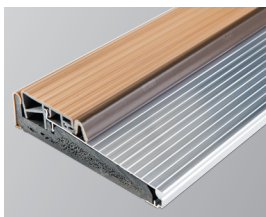

Aluminum Deck Colors*

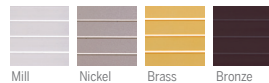

Co-Extruded Simulated Wood Cap Colors*

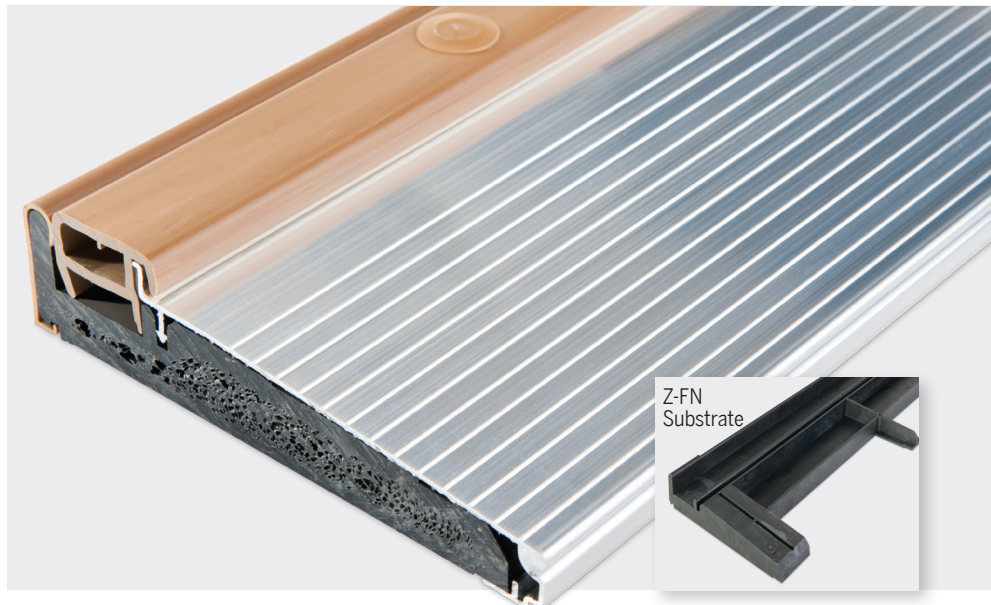
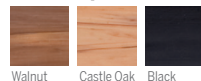

Z-FN Substrate

Z-All Aluminum

The Z-All Aluminum continuous lineal substrate combines flexible cutting for custom fabrication with an all aluminum construction that is perfect for high heat markets.

- All composite substrate
- Length up to 6'0"
- CSL up to 1/2-3/0-1/2; hinged patio up to 3/0-3/0
- Tileback edge option provides trim for tile floors

ZAA-Lineal Inswing



Aluminum Deck Colors*

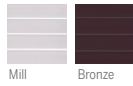

Aluminum Cap Colors*

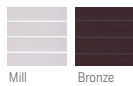

ZAA-FN Inswing



Continuous Sidelite

Tileback Edge Option

Z-Real Oak Cap

Get the performance and modularity of the Z-Series with a real wood cap that meets the aesthetic requirements of your millwork package.

- Available with all Z-Series composite substrates

Aluminum Deck Colors*

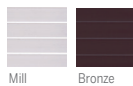

Real Oak Cap



Z-Series Articulating Cap Sill™

Z-Articulating Cap Sill™

The Z-Articulating Cap Sill™ is an auto-adjusting sill and built-in sealing system that redefines what your door system can do for you. Z-AC's innovative design never needs adjusting and forms a tight seal every time, even in imperfect conditions.

- Available in all Z-Series composite substrate options
- Available in All-Aluminum
- Self-compensating—never needs adjustment.
- Seals without corner pads.
- Seals with strike margins up to 5/32".

Aluminum Deck Colors*

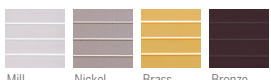

Co-Extruded Simulated Wood Cap Colors*

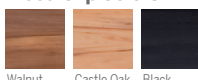

*Aluminum Deck and Co-Extruded Cap Colors availability may vary by sill widths.

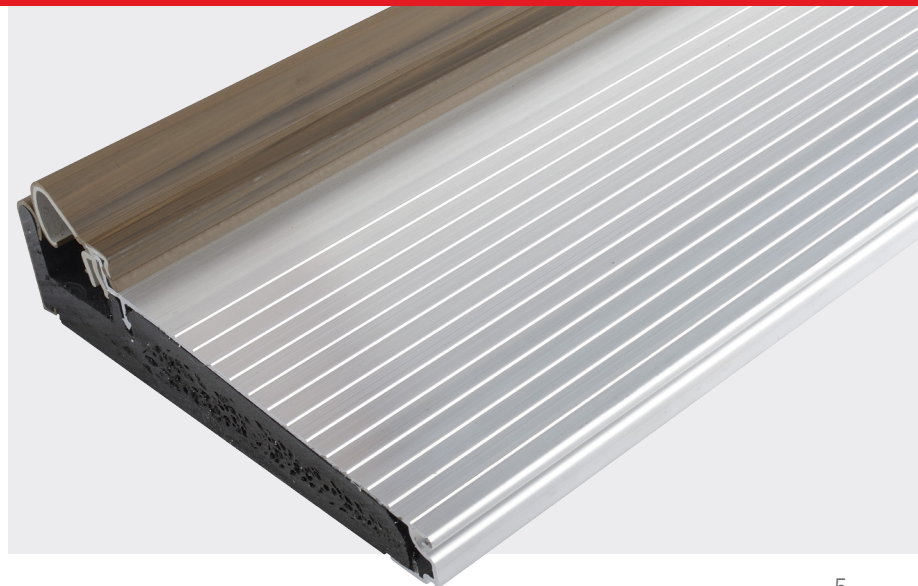

Z-Series Adjustable Sill Options

Z-Series Modularity

The modular design of the Z-Series Sill allows the Prehanger to switch out the inswing cap and replace it with a bumper outswing cap. And, with one continuous sill, you can reposition the active and sidelite caps to create a wide variety of door unit configurations. This allows you to hold your inventory count down.

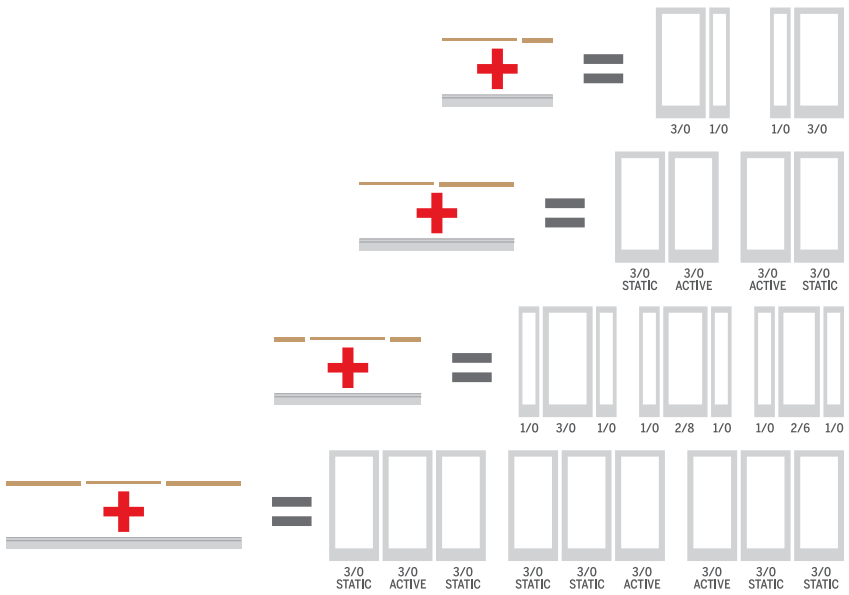

Any door system up to 12' can be built using modular Z-Series Sills. Start with the Z-Series Deck.



1 Add an inswing cap



2 For an inswing sill



3 Add an outswing cap



4 For an outswing sill



5 Add a sidelite cap



6 For a continuous sidelite

Continuous Sidelites

By providing a continuous seal across the door unit, you receive a better fit that prevents leaks. Patented inactive sidelite seats are repositionable for mull or patio system convenience.

- Continuous aluminum dam
- Mull haunched to properly fit the sill base



Fixed Convertible Cap

Designed specifically for the Z-Plus Sill, the fixed convertible cap allows easy replacement of the fixed cap portion of the sill with Endura's adjustable cap while leaving the sill nosing in place. No need to replace the entire sill.

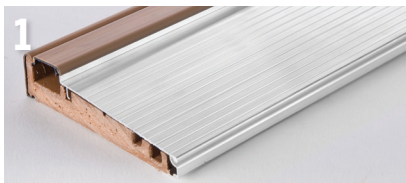

Inactive Panel Caps

For Mull/Patio Systems, the Z-Series features a line of patented repositionable panel caps.

- Cut to length for any combination of opening widths
- Adjustable inswing widths: 4-9/16", 4-7/8", 5-5/8", 5-13/16", 7-13/16"
- Bumper outswing widths: 4-9/16", 5-5/8", 5-13/16", 7-13/16"

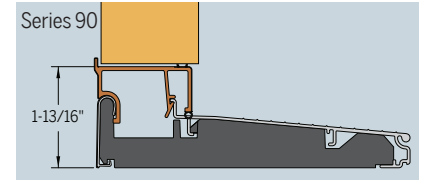
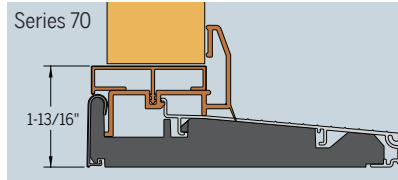
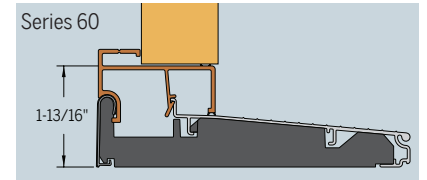
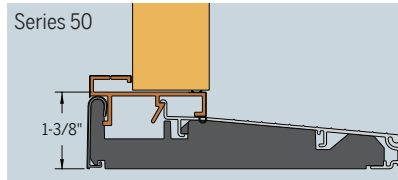

Notched Sill

Accommodates jamb stop in an outswing application.

- Entire profile of the jamb extends to the ground level
- No requirement for a jamb haunch
- Notched sills allow for the use of the same jamb inventory for both inswing and outswing applications, after the jamb is cut down.

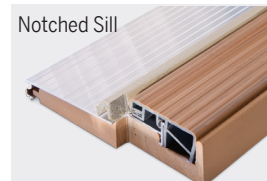

Notched and Horned Sill

- Horn fills the offset between the jamb edge and the brickmould
- Both the jamb and brickmould extend to the ground level
- No requirement for a jamb tennon
- Available in 5-5/8" and 5-13/16"

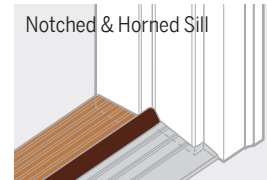
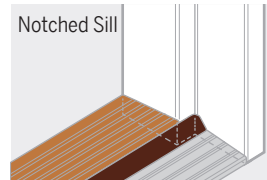

Machining Options

We provide both notched and horned sills that are compound cuts to match a straight cut jamb.

Sill Extenders*

5° Sill Extenders allow multiple sill widths from the same base sill.

4-9/16" Sill Extenders

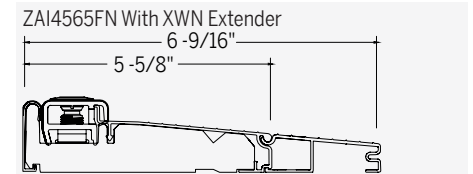
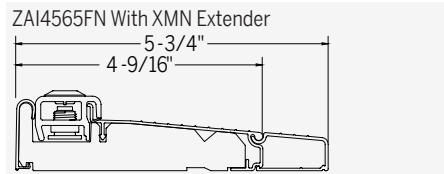
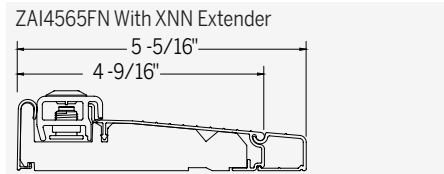

5-5/8" Sill Extenders

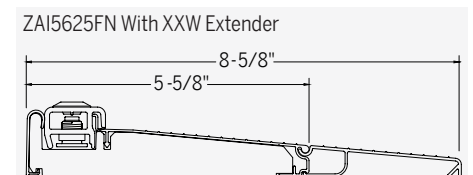
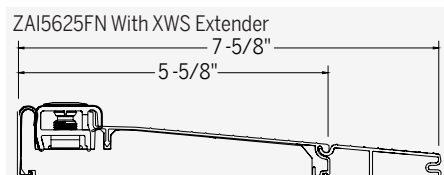
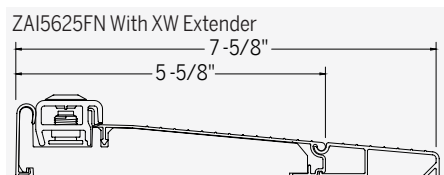
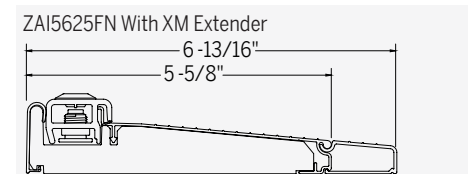
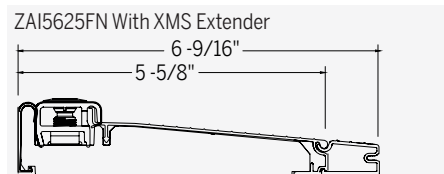
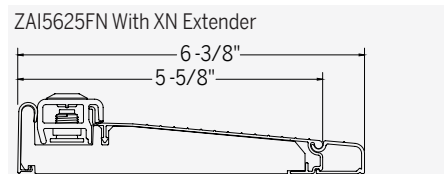

*Sill extender also available for 5-13/16"

Z-Series Adjustable Sills Options & Availability

Screen Rail

Single and double screen rails are available on adjustable inswing Z-Series Sills Available sizes: 5-5/8", 5-13/16" and 7-13/16".

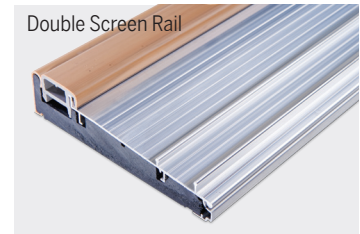
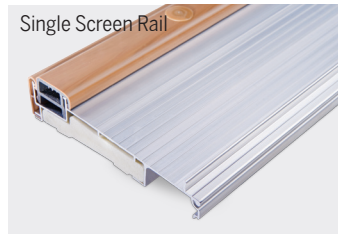

Double screen rail offered only in 5-5/8"

Sill Cover

Contoured for a precise fit, the sill cover protects the sill from construction damage and saves money on final clean-up. Flooring can be installed without removing sill cover. Patented design secures the cover front and back, yet can be easily removed.

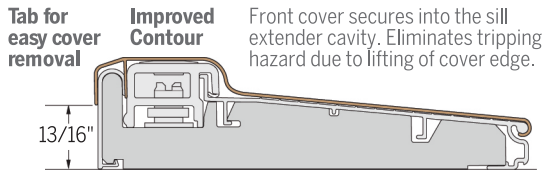

Z-Series Substrates

Z-Series Sills come in a variety of substrates designed to meet every need for cutability, flexibility in fabrication and final application.

Lineal



Full Wide (Z-Plus)



Full Narrow (FN)



ZOB 2" Extender

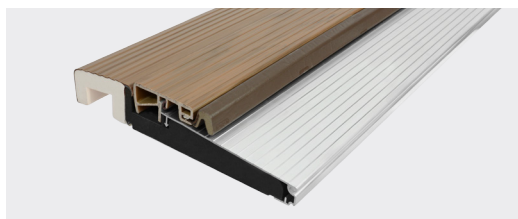

Specifications Overview

Structure	Z-Lineal	Z-Plus	FN	ZAA Lineal	ZAA FN
Composite Substrate	✓	✓	✓	✓	✓
Int. Thermal Break	✓*	✓	✓	✗	✓
Cutability	Unlimited	Limited	Limited	Unlimited	Limited

Aluminum Finishes

Mill	✓	✓	✓	✓	✓
Bronze	✓	✓	✓	✓	✓
Brass	✓	✓	✓	✗	✗
Brushed Nickel	✓	✓	✓	✗	✗

Cap Colors

Black	✓	✓	✓	✗	✗
Dark Walnut	✓	✓	✓	✗	✗
Castle Oak	✓	✓	✓	✗	✗
Mill	✗	✗	✗	✓	✓
Bronze	✗	✗	✗	✓	✓

Sill Width

3-1/2"	✓	✗	✗	✗	✗
3-3/4"	✓	✗	✗	✗	✗
3-11/16"	✗	✗	✓	✓	✓
4-9/16"	✓	✓	✓	✓	✓
5-5/8"	✓	✓	✓	✗	✗
5-13/16"	✓	✓	✗	✗	✗
7-13/16"	✓	✓	✓	✗	✗

Sill Cover Width

3-11/16"	✗	✗	✗	✓	✓
4-9/16"	✓	✓	✓	✓	✓
5-5/8"	✓	✓	✓	n/a	n/a
5-13/16"	✓	✓	✗	n/a	n/a
7-13/16"	✓	✓	✓	n/a	n/a

ZOB 2" Extender

Black, Walnut	✓	✓	✓	✗	✗
---------------	---	---	---	---	---

* Z-Lineal thermal break available in 5-5/8" & 7-13/16", only in mill finish

The information contained in this document is the confidential and proprietary information and trade secrets of Endura Products, Inc. Any disclosure, use or dissemination of such information without the express written permission of Endura Products, Inc. is strictly prohibited. Endura Products, Inc. also owns any and all intellectual property rights embodied in such information, including patent rights, copyrights, and trademark rights, and no license of any intellectual property right is intended, nor should any license be implied, as a result of the receipt of this document.

US Patents: 6,219,971; 6,789,358; 7,350,336; 8,413,383; 8,739,469; D599,490; D627,488; D632,556; D638,142; D638,143; D701,323.
Canadian Patents: 2,754,367; 2,847,449.

Effective: 2.17



8817 W. Market St., Colfax, NC 27235
1.800.334.2006 www.enduraproducts.com