

Field Installation Instructions

Ultimate Astragal Lite Outswing

Endura
DOOR COMPONENT SYSTEMS
800.334.2006
8817 West Market Street
Colfax, NC 27235

1 Position and Install Bolt Retainers

NOTE: To insure accurate hole locations for the astragal bolt retainers, first properly install corner pad on door hinge jambs to establish proper jamb side margins.

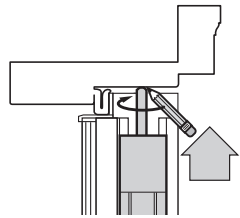

Close passive door until header weatherstrip is compressed. Push bolt pins to contact header and sill. Mark for drilling retainer holes.

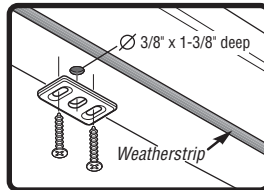
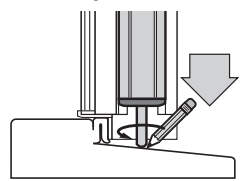

HEADER:

Drill a $\text{Ø}3/8"$ hole (1-3/8" deep minimum) into the header where marked. Attach the Upper Retainer with screws provided.

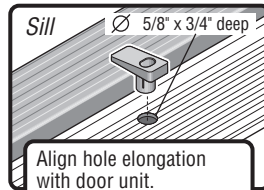

SILL:

Drill a $\text{Ø}5/8"$ hole (3/4" deep minimum) in the sill at the marked location. Insert Lower Retainer, orienting the long side of the hole parallel to the sill cap (as shown) and tap into place with a mallet.

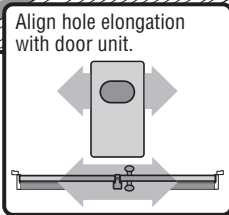

2 Position Strike and Deadbolt Plates

Close both doors. Mark desired positions for strike and deadbolt plates. Loosen the retainer screws. Place the strike and deadbolt plates into position and tighten the screws.

Endura recommends using the screws that came standard in the retainers.
NOTE: You will need to pre-drill through the astragal's aluminum body to the door panel to accommodate screws longer than 5/8" in length.

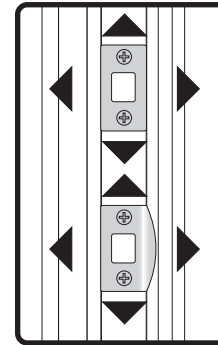

Check positions and adjust as needed.

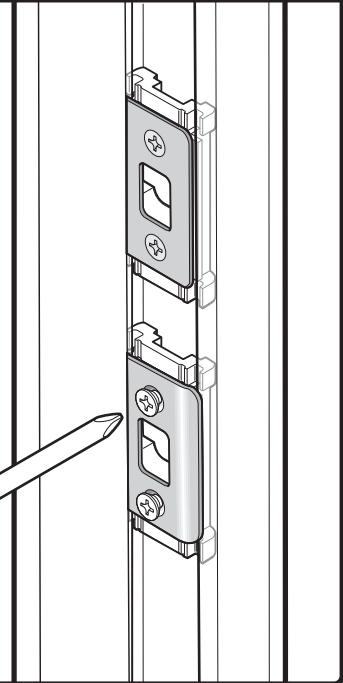

3 Install Trim Covers

Cut the Trim Covers so that the ends fit under the strike plates and butt up against the strike and deadbolt retainers (as shown [1, 2, 3]).

Loosen the screws on the strike and bolt plates and slip the trim underneath. Snap the trim pieces in place and tighten the screws.

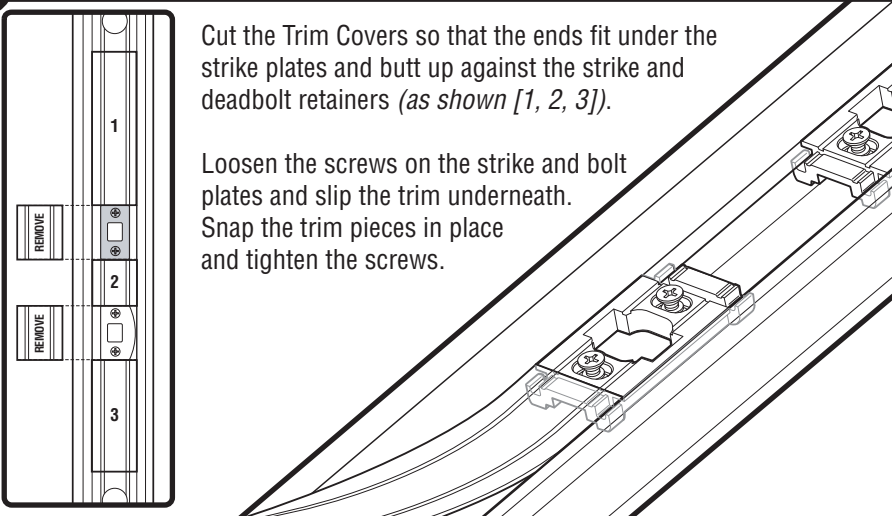

4 Slice Weatherstrip at Header

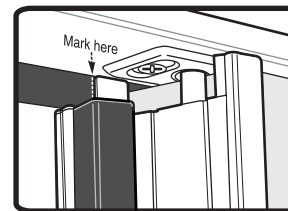

Step 1: With inactive door closed, use a sharp utility knife to mark the location on the header weatherstrip to be cut. The cut should be in line with the active door side of the trim cap fin.

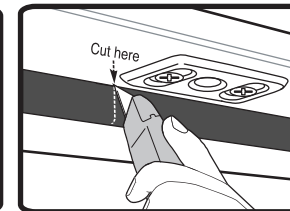

Step 2: Open the inactive door, then use the utility knife to cut the header weatherstrip on the mark made in Step 1.

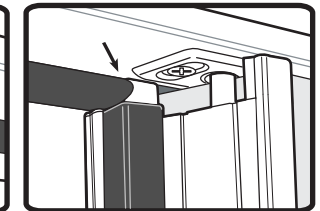

Result: Header weatherstrip should now clear the trim cap fin and contact the active door maintaining the integrity of the seal.